

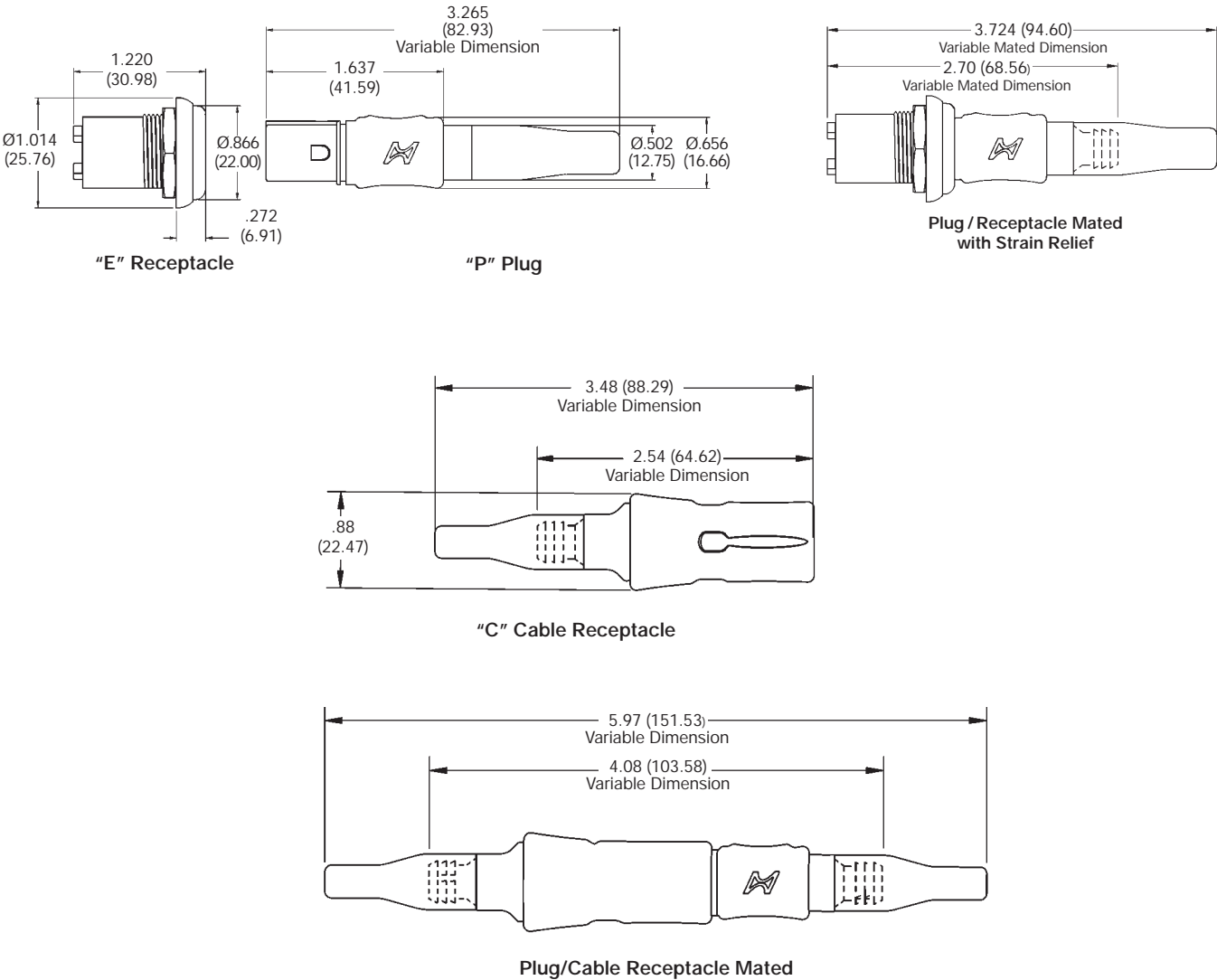

### Push/pull Quick Disconnect Plastic Connectors

- 12 contact positions
- 1 amp per contact
- Color coding (8 different colors)
- Overmoldable plug design
- Custom keyable (6 keying positions)
- Hypertac® contacts provide up to 100,000 mating cycles
- High-end engineering plastic components meet medical sterilizing and cleaning requirements
- Crimp and solder cup contact termination available (PC tails available on panel mount receptacle)
- Sealing option: IP67 (temporary immersion) when mated



Dimensions are inches (mm)

HG2 General specifications - HG2 12 Pin

Contact diameter in (mm)	.016 (0.4)
Current rating (amps)	1
Contact resistance (milliohms)	<8
Contact extraction force each (oz.)	.6 to 1.6
Contact life cycles	up to 100,000
Plug cycle life	up to 20,000
Breakdown voltage between contacts	>1,000V
Dielectric withstanding voltage	>750V
<i>Contact Material &amp; Plating</i>	<p><b>Sockets:</b> BeCu wires and brass body components 50 microinches of gold over nickel on wires Gold flash over nickel on all other socket components.</p> <p><b>Pins:</b> Brass 50 microinches of gold over nickel</p>
Insulation resistance	> 5 x 10 <sup>4</sup> Mv @ 500 VDC
<i>Temperature Rating</i> Polyetherimide, LCP, Silicone	-40°C to +105°C up to +185°C processing
Sterilization	Steam autoclave, Gamma, ETO

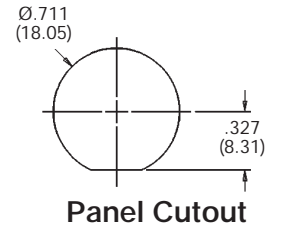

**Front Mounting Installation**

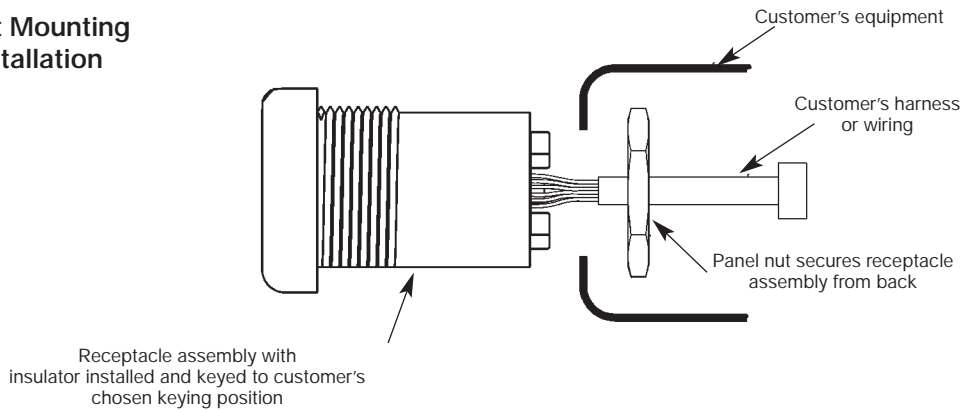

**Rear Mounting Installation**

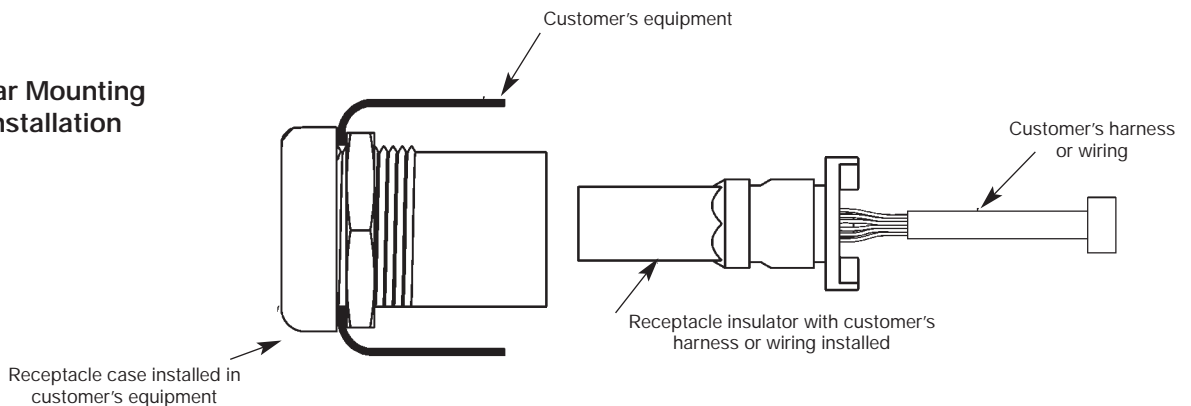

Dimensions are inches (mm)

### HG2 12 Pin - Ordering Information

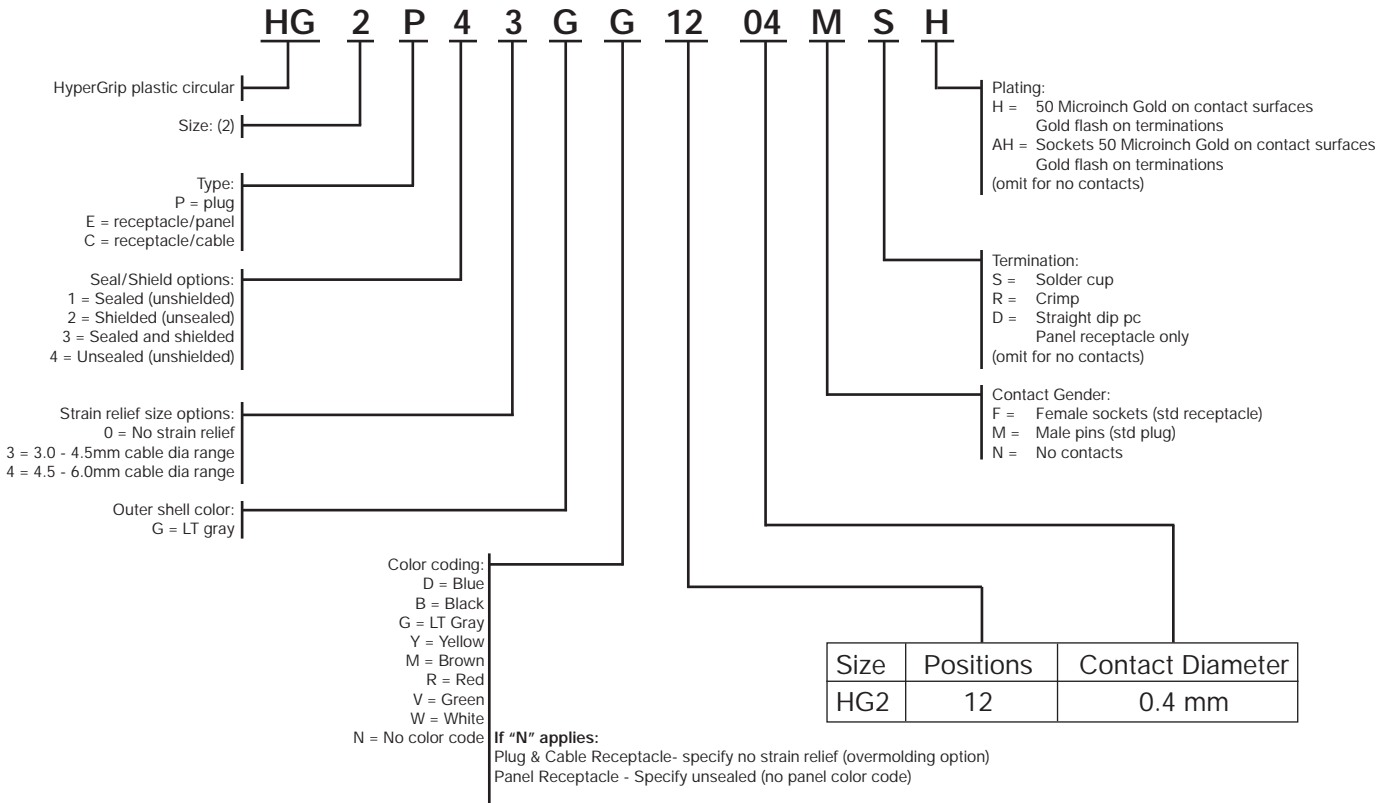

#### Keying Position A (receptacle wiring end)

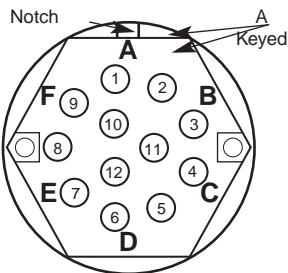

#### Keying Position B (receptacle wiring end)

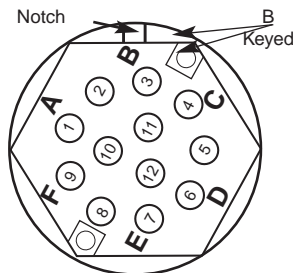

Note: 6 different keying positions possible - A through F

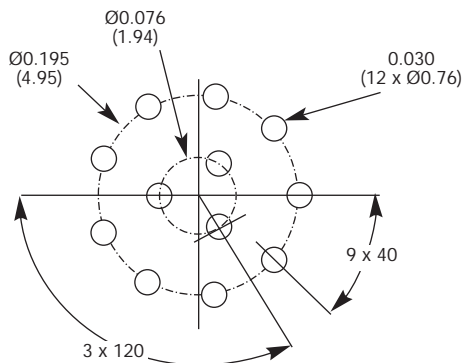

PCB Cutout (D Termination)

Contact Ordering Information		
Contacts	Part Numbers	Wire Gauge (AWG)
<b>Female Receptacle</b>		
Crimp Socket	YSK004-041AH	26 - 28
Solder Cup Socket	YSK004-039AH	26 MAX
PC Terminal Socket	YSK004-040AH	N/A
<b>Male Plug</b>		
Crimp Pin	YPN004-028H	26 - 28
Solder Cup Pin	YPN004-027H	26 MAX
<b>Male Receptacle</b>		
Crimp Pin	YPN004-029H	26 - 28
Solder Cup Pin	YPN004-026H	26 MAX
PC Terminal Pin	YPN004-030H	N/A
<b>Female Plug</b>		
Crimp Socket	YSK004-037AH	26 - 28
Solder Cup Socket	YSK004-036AH	26 MAX

Tools	Part Numbers
Crimp Tool	AFM8 or M22520/2-01
Positioner	T2030
Insertion Tool	T1916

Dimensions are inches (mm)